



# Dressage Attire & Equipment

2024

## **ACKNOWLEDGEMENTS**

The US Equestrian Dressage and Licensed Officials/Education Departments would like to thank the following for their contributions to this booklet:

United States Equestrian Federation, Inc. Dressage Sport Committee

Jean Kraus – Dressage Technical Delegate, Editor

Janine Malone – Dressage Technical Delegate, Assistant Editor

Lisa Gorretta – Dressage Technical Delegate, Assistant Editor

Copyright © 2024

Do not reproduce without permission of:

United States Equestrian Federation, Inc.

4001 Wing Commander Way

Lexington, KY40511 [www.usef.org](http://www.usef.org)

## Introduction

The purpose of this booklet is to assist Exhibitors as well as USEF Dressage Technical Delegates, Dressage Judges and Stewards who officiate Dressage classes at any Federation licensed competition. Exhibitors and Officials must be familiar with USEF Dressage Rules DR 120 and Dr 121 in the current USEF Rule Book, plus the accompanying photos and drawings. Illustrations through photos and drawings have been used to indicate what makes a particular piece of equipment or attire legal or illegal for use at Federation licensed competitions offering Dressage classes. **In no way does this booklet supersede the most current USEF Rule Book. There may be updates during the year and all competitors and officials should consult the current Rule Book prior to competing.** The USEF Bylaws, General Rules and Dressage Rules are found [Here](#) on the USEF website.

*Please be advised that the USEF Dressage Department only gives advisory opinions, not binding opinions, regarding the rules since ultimately it is the Federation Hearing Committee which applies facts and circumstances to the relevant rules and determines whether or not each fact constitutes a violation of the rules; and then only after a protest or charge of rule violation is brought before them. Nevertheless, the Federation is often asked to provide guidance regarding the rules and the Federation staff does assist when the rules seem to have clear application to a described situation. It should be noted, however, that the opinion expressed by a USEF staff member would not be binding on the Hearing Committee.*

*Bits/Equipment reviewed by the USEF Dressage Department are included with additional information, as an addendum to the Dressage Rules, and are published in Annex A on the USEF website.*

## Part One - Dress

### DR120 Dress

1. Dress. The Dress Code provisions of this section apply to all classes and levels, including Championships, at USEF Licensed-USDF recognized dressage competitions. FEI Dress rules apply only to FEI recognized dressage events (CDIs).

1.1 Protective Headgear. Protective headgear in compliance with the accepted testing standards published on the Federation's website. Protective headgear must carry the applicable quality testing tag and/or label. See GR801. From the time horses are officially admitted to the competition grounds by competition management, anyone mounted on a horse at any time on the competition grounds, including non-competing riders, riders on non-competing horses, mounted participants in exhibition classes, and those competing in all classes and tests, including Para Dressage tests, must wear protective headgear as defined by this rule and otherwise in compliance with GR801. The harness must be secured and properly fitted. Any rider violating this rule at any time must immediately be prohibited from further riding until the headgear is properly in place. Protective headgear may be the same as or coordinating color with the coat, and may include contrast coloring, accent and crystal decoration. See DR 136 for dress code rules for exhibitions.

1.2 Coats and Jackets. A short riding jacket or cutaway coat (modified tailcoat) with short tails is permitted at any level of competition. A tailcoat is permitted in all classes above Fourth level, in the FEI test for 7-year old horses and in tests for FEI Juniors. Any single color jacket or tailcoat is permitted and may have subtle pin striping, checks or tweeds. Striped or multicolored jackets or coats are not permitted. The color of stretch and/or breathable underarm or side of the body panel in a jacket may be black or the same color as the garment fabric. Tasteful and discreet accents, such as a collar of a different hue, modest piping, or crystal decorations, are acceptable. Only riders competing in Level 1 dressage competitions or in Opportunity classes are not required to wear a riding jacket or coat.

1.3 Vests. Vests of any type are permitted but not required. Vests, including cooling vests, may be worn underneath or outside a riding jacket or when jackets are waived.

1.3.1. Per GR801, a body protecting or inflatable vest, specifically designed for use in equestrian sport, may be worn in any division or class without penalty from the judge.

1.3.2. When the only warm-up available is open to all horses and riders, riders with safety concerns are encouraged to wear an orange vest.

1.4 Breeches and Jodhpurs. White, light or dark colored breeches or jodhpurs are permitted in competition. Bright colors or patterns are not permitted. Contrast piping is allowed.

1.5 Shirts and Neckwear. Shirts with tie, choker, stock tie, or integrated stand-up collar are required. Ties, chokers, or stock ties may be any color. If jackets or coats are not worn per DR 120.1.2 and DR 120.2.1, shirts may be any color, must have sleeves and a collar, and separate removable neckwear is prohibited. (See DR 120.3 Logos.)



On left - Helmet fitted and properly secured  
On right - Helmet fitted but not properly secured

Two examples of integrated standup collars. Both are allowed and can be used instead of a tie, choker or stock tie.



1.6 Boots & Half Chaps. For tests or classes at Fourth level or below, riders may wear tall boots or paddock/jodhpur boots with half-chaps or garters, matching the color of their boots, and made of smooth leather or leather-like material. Tall English-style riding boots, including dress or field boots or variations thereof, are required above Fourth Level. Boots of coordinating color(s), with or without accents, are permitted. Boots/shoes worn while riding anywhere on the competition grounds must have a distinguishable heel. (GR 801.9)

1.7 Gloves. White or light colored gloves are recommended and any solid color is permitted at Fourth Level and below. Gloves are required in FEI tests or levels and must be white, off white or same color as the coat.

1.8 Military. Current and retired members of the Armed Services and police units may ride in the uniform of their service. All riders who choose to wear Armed Services or police uniform must wear protective headgear as defined in DR120.1 and in compliance with GR801. Members of the Armed Services or police units may wear summer uniforms if jackets are waived.

1.9 Pas de Deux and Quadrille Attire. Riders in Pas de Deux and Quadrille classes are exempt from the dress code requirements of DR120.1.2, 1.4, 1.5, and 1.7. However, headgear and boots as required in DR120.1.1 and 1.6 must be worn. Riders must follow the dress requirements outlined in the USDF Rules and Guidelines for Quadrille Competitions and for Pas de Deux.



Half-chaps are allowed at Fourth Level and below.

2. Weather Conditions. In locations with high average heat and humidity on the date of a competition, competition management may publish in its prize list that jackets will be waived for the duration of the competition. Alternatively, management may announce prior to or during a competition that competitors may show without jackets when extreme heat and/or humidity is forecasted. This waiver applies to national classes at a USEF licensed-USDF recognized dressage competition.

2.1 Competitors must wear protective headgear and shirt with sleeves and collar, without neckwear. T-shirts are not permitted.

2.2 Competitors are permitted to wear a hat cover and a rain coat, with or without a riding jacket, in inclement weather.

3. Sponsor logo and Non-Sponsor Logo or Brand Marks. When sponsorship is permitted in accordance with GR1306, the name and/or logo of the individual's sponsor(s) may appear on each of the two sides of jackets and top garments at the height of breast pockets not exceeding 80 cm<sup>2</sup> in size. Logos described under DR121 are also permitted. No other sponsor logos are permitted on any garments (including jackets or coats, vests, shirts, or stock ties).

3.1 Dress may include non-sponsor logos or brand marks of any size. Refer to GR1306.

3.2 The name and/or logo of an individual's sponsor may also appear on the rider's protective headgear if permitted in accordance with GR1306 and DR121.1.b.

4. Spurs. Spurs must be made of metal. Only English-style spurs are permitted, as described below.

4.1 **If spurs are worn, a separate spur must be worn on each boot.** The shank must be either curved or straight pointing directly back from the center of the spur when on the rider's boot. If the shank is curved, the spurs must be worn only with the shank directed downwards. However, swan necked spurs are permitted. The inside arm of the spur must be smooth and one or both arms may have rubber covers. If rowels are used, they must be blunt/smooth and free to rotate. Metal spurs with round hard plastic knobs on the shank are permitted ("Impuls" spur). "Dummy" spurs (without shank) are permitted. Armless spurs are permitted.



4.2 Spurs are mandatory during competition in FEI Tests. However, spurs are optional for all of the FEI Children tests, FEI Pony tests, and the FEI and USEF test for 4-year-old horses.

4.3 The maximum length for spurs in all classes except the FEI Children tests and the FEI Pony tests is 5.08cm (2 inches) including rowels. Only blunt metal spurs (i.e., with no rowels) no longer than 3.5cm are permitted for FEI Pony Rider tests and FEI tests for Children. Except for FEI Pony Rider tests and FEI tests for Children, the length of the spur is measured from the base to the end of the shank. For FEI Pony Rider tests and FEI tests for Children, spur length is measured from the boot to the tip of the spur.

#### Spur Measurement

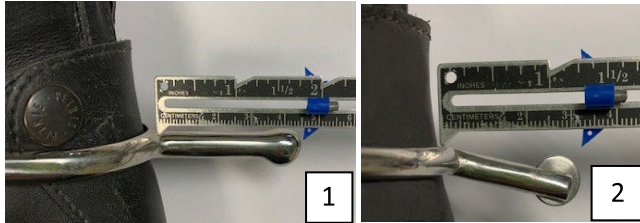

(1) The length of the spur is measured from the base to the end of the shank for all classes in USEF competitions, except FEI Pony Rider Tests and FEI Tests for Children.

(2) For FEI Pony Rider Tests and FEI Tests for Children at USEF Competitions, spur length is measured from the boot to the tip of the spur. FEI-recognized CDI-P and CDI-CH classes are also measured this way.

4.4 Offset spurs without rowel are permitted for riders having an appropriate Federation Dispensation/Classification Certificate.

**\*\*\*\* ATTENTION – There is an anticipated spurs rule change that will go into effect on 9/1/2024. \*\*\*\***

5. Electronic Communication Devices. Earphones and/or other electronic communication devices are strictly prohibited while competing and such usage is penalized by elimination. Electronic devices that transmit and/or receive information may be used in the stabling area and in warm up areas. The unsafe use of electronic devices, as determined by the competition Technical Delegate in their sole discretion, including cell phones, with or without earphones/buds, while mounted is prohibited in all areas designated for schooling and exercise, and while lungeing horses on competition grounds. Exception: medical devices, such as hearing aids are allowed to be used for the medical condition for which they are prescribed.

5.1 Electronic devices are permitted for Para Dressage riders if stated on their Federation Dispensation/Classification Certificate.

6. Federation Dispensation/Classification Certificates. Individuals holding Federation Dispensation/Classification Certificates may be allowed exceptions. See DR307. All exceptions to required dress must be listed on the rider's Federation Dispensation/Classification Certificate.



Exhibitor may wear a protective safety vest. Inflatable vests may be worn alone in Dressage Competitions. In dressage, body protecting vests are not required to be worn under inflatable vests. (See GR801.4)

When the only warm-up available is open to all horses and riders, riders with safety concerns are encouraged to wear an orange vest.



## Part Two – DR 121 Saddlery and Equipment

The provisions of DR121 apply to both competing and non-competing dressage horses from the time horses are admitted to the grounds, which are designated for the Dressage Competition. The responsibility for the correct attire and equipment rests with the competitor. All saddlery and equipment must be attached, worn, and used in a conventional manner.

### 1. Saddle.

An English type saddle, with or without a tree, with flaps, stirrups and a girth is compulsory for all tests and classes other than FEI tests. For FEI tests it is compulsory to use a well-fitting dressage saddle that is close to the horse with long, near-vertical flaps and stirrups (except for FEI Para Dressage tests) and a girth. The use of a saddle with a horn, swell, gallerie, or open gullet, or the use of an original or modified Australian, Baroque, Endurance, McClellan, Spanish, Stock, or Western saddle is prohibited. See DR308.4 for Para Dressage requirements.

- a. Stirrups. English-style stirrups without attachments or safety stirrups shall be used. Safety stirrups must have closed branches of metal or other breakaway material or mechanism. The foot must not be fully or partially enclosed and must in no way be attached to the stirrups (for example with magnets); however, a safety stirrup may have a magnetic mechanism that closes the breakaway branch. The stirrup leathers must hang freely from their anchor point without additional attachments to the saddle or girth.
- b. Saddle pads. Saddle pads are optional and when used must be white or of conservative color. Contrast trim and piping are permitted. Striped or multi-colored pads are not permitted. Glitter or reflective pads are not permitted, although pads may have crystals or reflective materials on borders. Brand marks or non-sponsor logos not exceeding fifty square centimeters (50cm<sup>2</sup>), which is approximately 7.75 sq. inches, are permitted. While in the competition ring and during awards ceremonies, a logo, monogram or name may appear on either or both sides of a saddle pad. Logos shall not exceed 200 sq. cm (26.632 sq. inches) in size. Only the following logos or names are permitted: a breed logo for horses registered with that breed; a national flag for citizens of that country; Federation or USDF names/logos. Professionals of any age may have a business or product name/logo of their official sponsor. Amateurs shall not have a business or product name/logo displayed unless they own the business. Competition award pads and stable name pads are permitted. No other advertisement or publicity is permitted on saddle pads or horses, except as noted in DR121.8 fly hoods.
- c. Seat covers. Seat covers are, under penalty of elimination, strictly prohibited. However, saddle covers are permitted in inclement weather.
- d. Safety strap. For purposes of rider safety, a short strap in front of the pommel may be attached to the D rings or to the stirrup bars.

### 2. Bits

Only those bits listed in Figure 121.1, Figure 121.3, Figure 121.4, and Annex A are permitted. Bits must be used in a conventional manner and attached only as illustrated in the diagrams. The type of bit should not vary from those pictured below except specified. All bits must be smooth with a solid surface. Twisted bits, bits with “bumps”, bits with uncovered wire or cable, and bits that place mechanical restraint upon the tongue are prohibited. Joints that could trap or pinch the oral tissues are not permitted.

- a. Snaffle bits - A snaffle is a non-leverage bit with the rein attached at the level of the mouthpiece. The rein and cheekpiece attach to the same ring and can rotate freely around that ring. Exception: hanging cheek snaffles.
  1. A snaffle bit may be a combination of any mouthpiece and any cheekpiece pictured in Figure 121.1 and should be attached only as shown.
  2. The mouthpiece of a snaffle bit must be made of metal, flexible rubber, or synthetic material. A metal mouthpiece may have a covering of rubber or plastic (in manufactured state), but the bit cannot be modified by adding latex or other material. Leather or leather covered bits are prohibited. The contours of the bit must conform to those of the bits pictured in Figure 121.1. When joint(s) are present in the mouthpiece, they may lock.
  3. The snaffle mouthpiece must have a minimum diameter of 10 mm where it meets the rings or cheeks. Snaffles used in Young Horse and Children’s classes must have a minimum diameter of 12 mm. Exception: for ponies, the diameter may be less than 10 mm for riders of any age.

\*\*\*\* ATTENTION – There is an anticipated change to DR 121.2.a.4 that will go into effect on 9/1/2024. \*\*\*\*

4. A snaffle bit may be unjointed, single-jointed, or double-jointed. The center link in a double-jointed snaffle must be smooth and curved on all surfaces as in a lozenge-shaped link. It may not have the effect of a tongue plate. Dr. Bristol and French link bits are not allowed. The center joint or link may be tilted in a different orientation tilted in a different orientation from the mouthpiece and may have a bushing, barrel, coupling, or ball joints. The surface of the center piece must be solid or have only one rolling part in the center of the mouthpiece, as pictured in Figure 121.1.
5. The mouthpiece of a jointed or unjointed snaffle may be shaped to allow tongue relief. The maximum height of the deviation is 30 mm from the lowest part of tongue side to the highest part of the deviation. The widest part of the deviation must be where the mouthpiece contacts the tongue and must have a minimum width of 30 mm (Figure 121.2). Ported snaffles that do not meet these specifications are prohibited.
6. The upper cheek of a hanging cheek (baucher) snaffle (measured from the top of the mouthpiece to the top of the upper cheek) may not exceed **seven** centimeters.

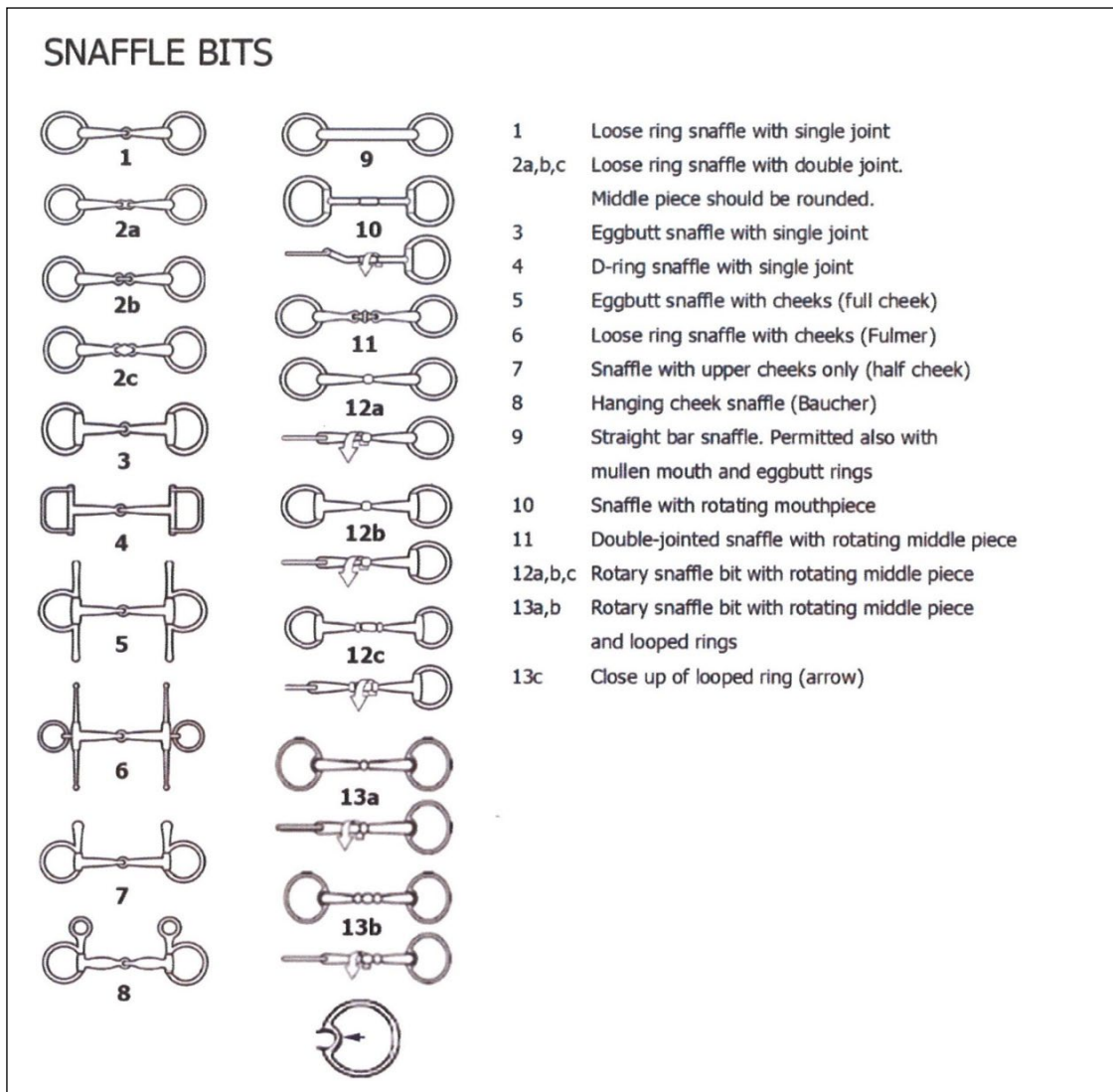
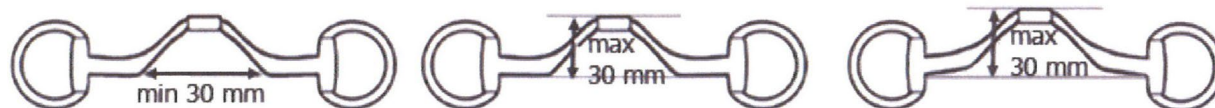

Figure 121.1: Permitted snaffle bits. The snaffles pictured and described here are permitted at any level (national and FEI) in which it is permitted to use a snaffle. However, keepers are only permitted in national level tests for full cheek, half cheek, and fulmer snaffles pictured above (bits numbered 5, 6 and 7) See also Annex A posted on the USEF website for additional information on permitted and prohibited snaffle bits.



Figure 121.2: Measurement of tongue relief for a snaffle bit. The widest part of the deviation must be where the mouthpiece contacts the tongue and must have a minimum width of 30 mm (left). The maximum height of the deviation is 30 mm from the lowest part of tongue side to the highest part of the deviation (center and right).



### b. Bridoon bits

A bridoon is defined as a snaffle bit used together with a curb bit to form a double bridle. A bridoon is a non-leverage bit with the rein attached at the level of the mouthpiece. The rein and cheekpiece attach to the same ring and can rotate freely around that ring. Any of the bridoon mouthpieces shown in Figure 121.3 may be combined with a loose ring or eggbutt ring. However, D rings, full cheeks, half cheeks and hanging cheeks are prohibited on bridoon bits.

1. A bridoon bit must be made of metal or durable plastic, flexible rubber or synthetic material and may be covered with rubber (in manufactured state).
2. The bridoon mouthpiece must have a minimum diameter of 10 mm where it meets the rings.
3. The mouthpiece of a bridoon must have one or two joints and conform to Figure 121.3. In a double-jointed bridoon, the center link must be smooth and curved on all surfaces as in a lozenge-shaped link. It should not have the effect of a tongue plate. Dr. Bristol, French link, and D-ring bridoons are not allowed. A bushing, barrel, coupling, or ball joint is permitted as the center link in a double-jointed bridoon. Only one rolling part is permitted and when present the rolling part must be in the center of the mouthpiece as pictured in Figure 121.3. The center link may be tilted in a different orientation from the mouthpiece. Bridoons in which the joints of the center link can lock and have the effect of a mullen-mouth snaffle, are prohibited.

Figure 121.3: Permitted bridoon bits. Bridoon bits are used in combination with a curb bit to form a double bridle which is permitted only at Third Level and above. See also Annex A posted on the USEF website for additional information on permitted and prohibited bits.

## BRIDOOON BITS

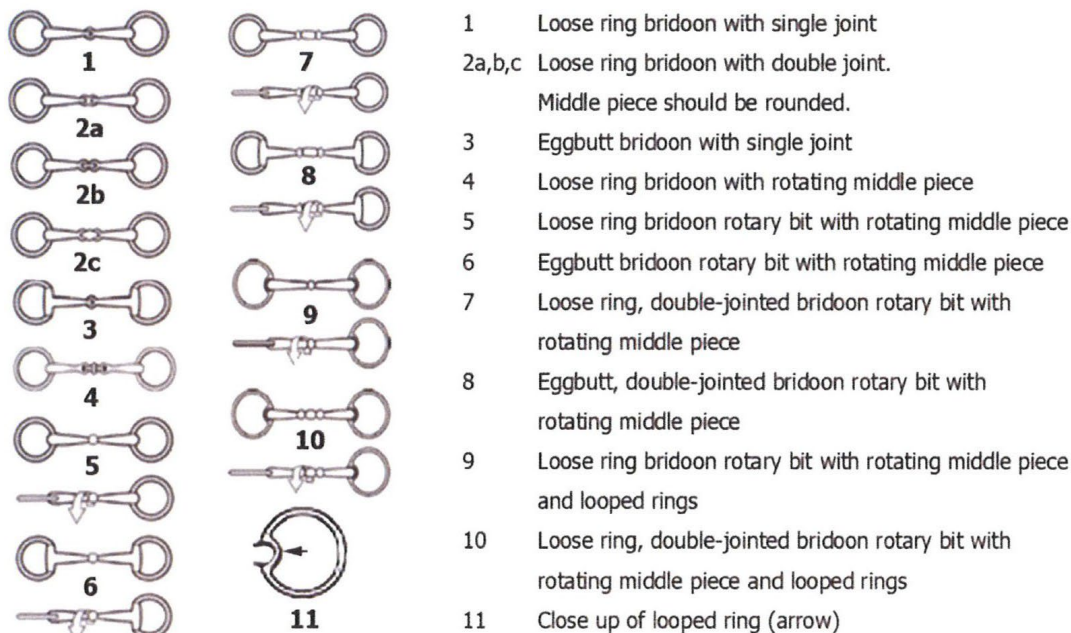

### c. Curb Bits

A curb bit is an unjointed leverage bit used together with a bridoon in a double bridle. It must conform to Figure 121.4.

1. A curb bit must be made of metal or durable plastic, flexible rubber or synthetic material and may be covered with rubber (in manufactured state).
2. The curb mouthpiece must have a minimum diameter of 12 mm where it meets the cheeks.
3. A curb mouthpiece has no moveable pieces or joints but it may be shaped to allow tongue relief.
4. Leverage is achieved by having cheeks extend above and below the mouthpiece to which the cheek piece and the rein, respectively, are attached. Bits in which the mouthpiece attaches to the same ring as either the cheek piece or the rein are not permitted as curb bits. The cheeks may be straight or S-shaped.
5. The mouthpiece may be attached rigidly to the cheeks, may rotate and slide vertically, relative to the cheeks. The lever arm of the curb bit, determined by the length of the cheek below the mouthpiece, shall be no more than 10 cm (3.9 inches). The upper cheek must not exceed five centimeters. The method of correct measurement of the upper and lower cheeks is shown in Figure 121.5.

Figure 121.4: Permitted curb bits. Curb bits are used in combination with a bridoon bit to form a double bridle which is permitted only at Third Level and above. See also Annex A posted on the USEF website for additional information on permitted and prohibited bits.

### CURB BITS

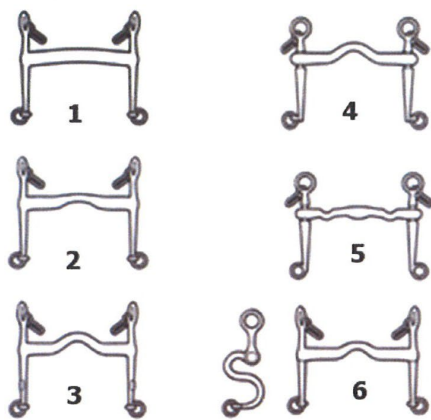

- 1 Half-moon curb bit
- 2,3 Curb bits with straight cheeks and port
- 4 Curb bit with port and sliding mouthpiece
- 5 Curb bit with shaped, sliding mouthpiece
- 6 Curb bit with S-shaped cheeks
- 7 Curb chain (metal or leather or a combination)
- 8 Lip strap
- 9 Leather cover for curb chain
- 10 Rubber or leather or sheepskin cover for curb chain

\* Curb chain hooks can be fixed or not fixed

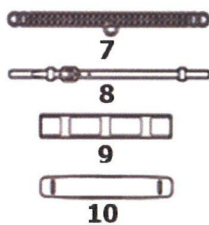
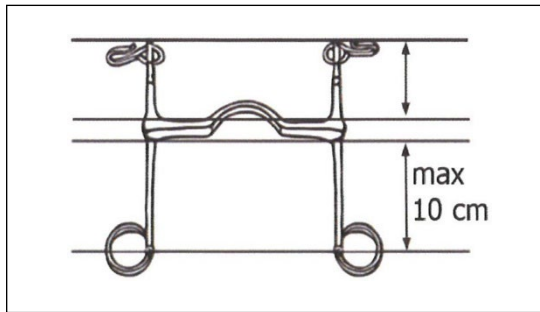

Figure 121.5: Measurement of lengths of the cheeks of a curb bit. The lower cheek, which acts as the lever arm, must not exceed 10 cm in length measured from the underside of the mouthpiece. If the curb has a sliding mouthpiece, the length of the lower cheek is measured with the mouthpiece in its uppermost position. The upper cheek must not exceed the length of the lower cheek measured from the upper side of the mouthpiece to the top of the ring to which the cheek piece attaches as shown in the diagram. If the curb has a sliding mouthpiece, the length of the upper cheek is measured with the mouthpiece in its lowest position.



### 3. Bridle.

Permitted bridles and bits must be used in a conventional manner. The headstall and noseband must be made of leather or leather-like material except the buckles, wear tabs on cheek pieces and reins, and a small disk of sheepskin used at the intersection of the two leather straps of a crossed noseband. Nylon or other non-metallic material may be used to reinforce leather in the headstall but must not come in direct contact with the horse. Elastic inserts are permitted only in the crownpiece and cheekpieces. Bit snaps, buckles, or hooks/studs to attach cheekpieces to the bit are permitted.

a. Crownpiece. The crownpiece of the bridle must lie immediately behind the poll and may extend forward onto the poll, but it may not be fitted to lie on the vertebrae behind the skull (Figure 121.6). The crownpiece may be padded and it may have elastic inserts. Any padding is limited to the dimensions for the crownpiece as indicated in Figure 121.6. Any piece of tack or equipment that impairs the ears to move freely is not permitted.

\*\*\*\* ATTENTION – There is an anticipated change to DR 121.3.a. that will go into effect on 9/1/2024. \*\*\*\*

Figure 121.6: Position of crownpiece behind the poll. Arrows show the acceptable limits for the width of the crownpiece.



b. Browband. A browband is required and, except for the parts that attach to the crownpiece or headstall, is not required to be made of leather or leather-like material. At any level of competition, a browband may be multicolored and may be decorated with metal, beads, gemstones and crystals.

c. Throat latch. A throat latch and/or a jowl strap is required. A jowl strap is considered a throat latch that can be used to replace or used in addition to a traditional throat latch. In order to replace the throat latch, the jowl strap **MUST** be fitted around or immediately below the horse's jowl (Figure 121.7). Nosebands with one or two lower (chin) straps must also have a throat latch, as described above. Exception: Micklem Bridle. The back strap (or chin strap) of a noseband cannot also be considered a jowl strap.

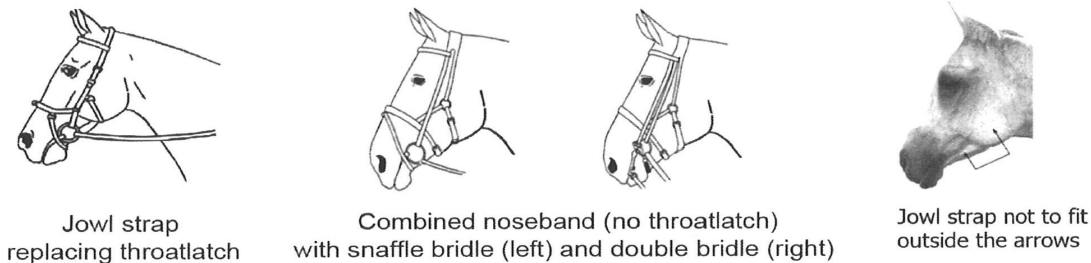
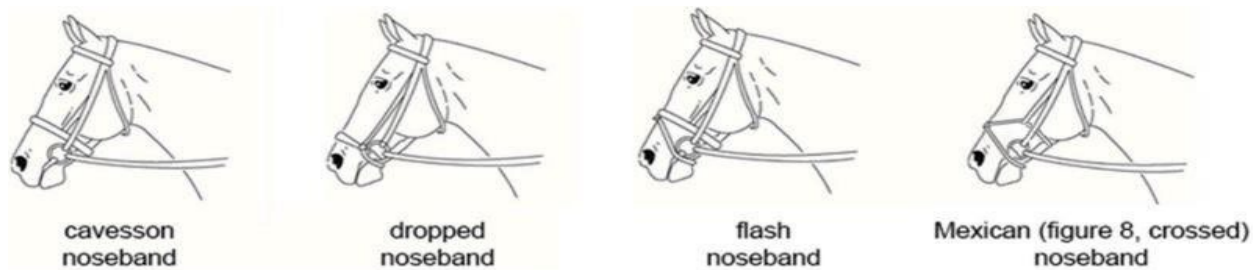

Figure 121.7: Bridle with jowl strap replacing throat latch (left). Bit snaps may not be used with this bridle. Combined noseband (no throatlatch) permitted for use in at any level (including USEF High Performance classes) and in warmup with either a snaffle (middle left) or double bridle (middle right) as appropriate for the level. When used as a double bridle, the lower strap of the noseband (flash attachment pictured with the snaffle on left), is prohibited. Limits for placement of jowl strap (right).



d. Noseband. A noseband is required and may be a regular cavesson or noseband with an adjustable back piece or chin strap, a dropped noseband, a flash noseband (combination of a cavesson and an attached dropped noseband), or a Mexican (figure-8, crossed) noseband (Figure 121.8) except as prohibited in some competitions (see DR121.3.10) A double bridle must be used with a cavesson with or without an adjustable back piece or chin strap.

\*\*\*\* ATTENTION – There is an anticipated change to DR 121.3.c. that will go into effect on 9/1/2024. \*\*\*\*

Figure 121.8 Permitted nosebands with a snaffle bridle, left to right, cavesson, drop, flash and Mexican. It is permissible to use the cavesson noseband with an adjustable back piece or chin strap.

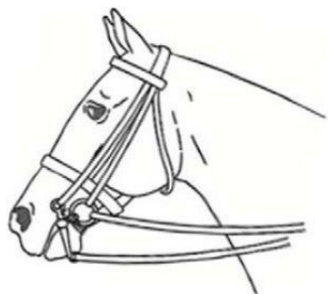

Figure 121.9: A cavesson is the only noseband permitted with a double bridle. A cavesson noseband with an adjustable back piece or chin strap is permitted.

1. The noseband itself may be padded and/or used with a chin pad. Decorations are permitted but must be attached only to the outer surface of the noseband; nothing may protrude through or be close to the inner surface of the noseband.



2. Nosebands shall not be adjusted so tightly that it causes skin irritation. It must be possible to insert two fingers under the noseband on the side of the face below the cheekbone. During a tack check, noseband tightness must be checked at the location shown in Figure 121.10 and not on the bony area of the cheekbone or bridge of the nose.

Figure 121.10: Measurement of noseband tightness. Cavesson tightness is measured on the side of the face below the cheekbone (left). Flash noseband tightness is measured to the side of the nasal bones.

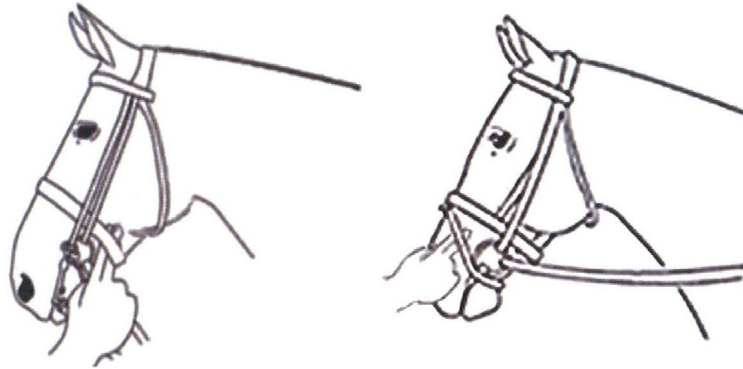

- e. Reins. A rein is a continuous, uninterrupted strap or line connecting the bit to the hand. Each bit must be attached to a separate rein and reins may only be attached to bits. Rein additions or attachments are prohibited. Snaps that attach reins to the bit are permitted. Reins may be made of leather, leather-like material, or webbing. The material may be rubberized or have a rubber covering and rein stops may be present. The reins must not be made of rope or rope-like material.
- f. Curb chain. The curb “chain” can be made of metal, leather, or a combination (Figure 121.4). A rubber, leather, or sheepskin cover for a curb chain is optional. The curb chain may never be so tightly fixed as to harm the horse. Curb chain hooks are required and can be fixed or not fixed.
- g. Lip strap. A lip strap is optional.
- h. Snaffle bridle. A snaffle bridle has a snaffle bit attached to a single rein. A cavesson, noseband with an adjustable back piece or chin strap, dropped, flash, or crossed noseband is permitted when a snaffle bridle is used in warmup or competition, except as prohibited for some tests.
- i. Double bridle. A double bridle has bridoon and curb bits each attached to a separate rein. The curb bit must have a curb chain. A cavesson with or without an adjustable back piece or chin strap is required and is the only noseband permitted with a double bridle.
- j. Bridles allowed in USEF (national) competitions
  1. For Tests at Second Level and below, FEI Tests for Children, and FEI Pony tests, a plain snaffle bridle is required in warmup and in competition.
  2. For Third and Fourth Level tests a snaffle bridle or double bridle are permitted in the warmup and in competition.
  3. For FEI tests ridden at national competitions, a snaffle bridle or double bridle may be used in competition and in the warm up, as described above in DR121.2
  4. Qualifying and championship classes. Either a snaffle bridle or double bridle is permitted for USEF High Performance and USEF Young Adult qualifying classes held at national competitions. A double bridle is required for USEF Grand Prix and Young Adult championship classes at the USEF Festival of Champions. Snaffle bridles are permitted for NAYC qualifying and championship classes, USEF Young Rider qualifying and championship classes, and USEF Junior qualifying and championship classes.

5. Young horse classes. For the FEI Dressage Tests for 4, 5, and 6-year-old horses and the USEF Dressage Test for 4-year-old horses, a snaffle bridle is required, as above (DR121.2.a). Either a snaffle or double bridle may be used in the FEI test for 7-year-old horses. Snaffle bits used in FEI tests must conform to Figure 121.1 and Annex A. The crossed (Figure-8, Mexican) noseband is prohibited for the FEI Dressage Tests for 4, 5, 6, and 7-year-old horses and the USEF test for 4-year-old horses.

6. Para Dressage athletes. Riders competing only in FEI Para Dressage tests may use either a snaffle bridle or double bridle. Riders competing in both FEI Para Dressage tests and USDF or USEF tests at the same competition at second level and below, must use a plain snaffle bridle in all tests and warmup for those tests. When competing only at third level or above, a snaffle bridle or double bridle may be used in warm-up and in competition.

4. Martingales. Martingales are, under penalty of elimination, prohibited in competition. In warmup and other training areas, a running martingale may be used only with the rein of a snaffle bridle. Exception: running martingales are prohibited for horses entered in USEF High Performance qualifying and selection trials. A running martingale consists of a divided strap attached to the girth or breastplate at the front of the horse's chest and with the extension of each strap connected from the point of division only to the rein on the same side. The reins must slide freely through the rings. The rings may not be incorporated into a neck strap.

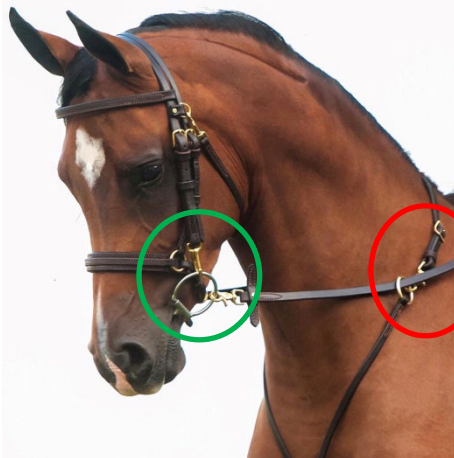

Picture on the left is the traditional running martingale and is legal.

The martingale on the right is considered a gadget and is not legal.

The bridle on the right has clips/snaps that attach the cheekpieces to the bit and the reins to the bit. These are legal.

5. Gadgets such as bearing reins, side reins, running reins, balancing reins and auxiliary reins. In the warmup and in classes gadgets such as bearing reins, side reins, running reins and balancing reins, are, under penalty of elimination, strictly forbidden. See DR121.19 for rules describing the use of side reins during lungeing.

6. Breastplates and cruppers. A breastplate and/or crupper may be used. Exception: a breastplate is prohibited in USEF High Performance Championships, USEF High Performance Qualifying and Selection Trials.

7. Neck straps. Neck straps of any material are not permitted in the warmup or in competition.

8. Fly hoods. Fly hoods (ear covers) that do not cover the horse's eyes can be used to protect horses from insects. Fly hoods may not be attached to the noseband. They should be discreet in color and design, and may have a promotional or manufacturer's logo that is in compliance with DR121.1.b.

a. Fly hoods are permitted in the warmup and other training areas and for all classes.

b. Fly hoods may be noise-cancelling in manufactured state but cannot be used with earplugs.

c. If a tack inspection is performed after completion of the test, the rider or his/her representative is responsible for removing the fly hood and presenting it for inspection to the designated ring steward who will ensure that nothing prohibited has been added, such as ear plugs.

d. Blinkers or goggles (with clear or tinted full eye cups) that cover the horse's eyes but do not obstruct the horse's vision are permitted in the warmup but are prohibited in the competition arena. Fly masks are forbidden in warmup, training areas and competition.

e. Cooling caps (hoods) are prohibited in competition and warmup areas.

9. Ear plugs. Ear plugs and ear muffs are, under penalty of elimination, prohibited. Exception: Ear plugs are permitted at prize-giving ceremonies for horses competing at any level, including High Performance classes.

10. Body tape and body bands. The use of equine body tape (kinesiology tape) and resistive or elasticated body Bands are prohibited on the show grounds.
11. Boots and bandages. Boots and bandages without magnets are permitted in the warmup and other training areas. In competition the use of any kind of boots or bandages that contact the horse's legs on or above the hairline at the coronet or tail bandages are under penalty of elimination prohibited. Exception: leg bandages are allowed in Pas de Deux and Quadrille classes.
12. Shoes. Shoes, with or without clips, complete cuffs or partial cuffs, that are attached with nails or glue or wraps are permitted. No part of the cuffs or wraps may extend on to or above the hair line at the coronet. Wraps are also permitted without shoes.
13. Nose net. A nose net may be used in the warmup and in competition provided the entry is accompanied by a signed letter from the horse's veterinarian. A copy of this letter must be attached to each test or class sheet. The letter must be written on the veterinarian's stationary and clearly state that the horse has been diagnosed with head shaking syndrome and the syndrome is improved with the use of a nose net. The letter must also state the brand of nose net to be used. The Federation's website has a list of nose net brands that are approved for dressage.
14. Nasal strips, bit guards, and tongue ties are, under penalty of elimination, prohibited during exercise or in competition.
15. Mane, tail and body. Braiding of the horse's mane and tail is permitted. False tails are permitted, but a false tail may not contain any metal parts, except hooks. An existing wound or injury cannot be obscured. Decoration of the horse with extravagant items, such as ribbons, flowers or glitter in the mane, tail or on the body, including hooves, is prohibited. Exception: A red ribbon in a horse's tail is permitted to identify a horse that kicks. Only standard horse colors that occur naturally on that horse may be added to the mane, tail or body.
16. Mouth. Any type of substance applied around the horse's mouth (i.e. marshmallow fluff or shaving cream) to imitate foaming is strictly forbidden under penalty of elimination.
17. Identification tags. One small identification tag, no larger than 1.5" diameter, may be attached to the horse's mane.
18. Whips. The length of the lash is included in measurements of the length of the whip. For schooling the rider while mounted is permitted to carry one whip that is no longer than 120 cm (47.2 inches) or 100 cm (39.4 inches) for FEI Pony Riders. One whip no longer than 120 cm (47.2 inches) may be carried in all classes except, under penalty of elimination, USEF/USDF Championships, USEF National Dressage Championships, USEF High Performance Championships, and USEF High Performance qualifying and selection trials. Exception: Competitors riding side-saddle may carry a whip no longer than 120 cm (47.2 inches) in USEF/USDF Championships. One whip no longer than 120 cm (47.2 inches) may be carried in all qualifying classes (including NAYRC and NAJC) unless such use is otherwise prohibited by FEI or Federation rules or selection procedures for the classes. However, when a whip is permitted for FEI Pony Tests, the maximum length is 100 cm (39.4 inches). An adjustable-length whip may not be carried by a mounted rider. The use of one lungeing whip is permitted only when lungeing. There is no restriction on the length of whip permitted for working a horse in hand or on the lunge. Rules regarding whip use at USEF High Performance qualifying and selection trials. The following rules (17.1 and 17.2) apply exclusively to use of a whip at USEF High Performance qualifying and selection trials:
  - a. Upon arrival on the showground, only the rider while riding, walking, leading or lungeing a horse (lunge whip allowed) is allowed to use a whip (maximum 120 cm) in connection with the training of the horse. The groom may also walk, lead and lunge a horse as above.
  - b. The whip must be dropped before entering the space around the competition arena or the rider will be penalized for an error (see DR122.5.j).
19. Numbers. All competitors must complete check-in at the show office and receive a show number, before schooling or riding on the show grounds. **Failure to check in at the show office prior to schooling will result in the issuance of a warning card.** Competition-assigned numbers, or the same number in a personal numbering format, must be worn and visible at all times when a horse is being hand-walked, exercised or ridden, under penalty of elimination.
20. Lungeing. Longeurs must use a single lunge line that goes directly to the hand of the longeur and attaches to a halter, lungeing cavesson, or the snaffle bit of the bridle (either on the same side as the handler or across the head or under/around the chin to the snaffle ring on the opposite side from the handler). A double bridle may not be worn while lungeing.

21. Single direct side reins, which are affixed to the bit and to the girth, saddle, or surcingle on the side of the horse (not between the legs), or double sliding side reins (triangle reins) are permitted only when lungeing (mounted unmounted). Double sliding side reins may be attached to the saddle, surcingle and/or girth as pictured in Figure 121.11. Driving and long lining are prohibited.

Figure 121.11: Side reins permitted during lungeing. Left to right: single direct side rein, triangle rein attached between the legs, and triangle rein attached on the side of the chest.

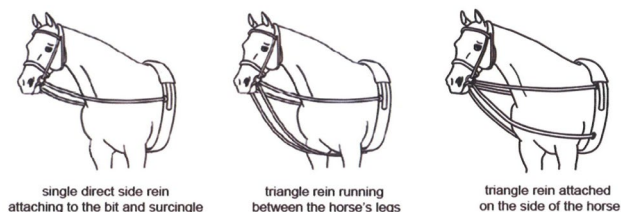

22. Dispensation/Classification Certificates. Athletes holding a Federation Dispensation/Classification Certificate may use special saddlery and equipment as specifically listed on their Certificate. Refer to DR 307-308 for a list of compensating aids and saddlery permitted for Para Dressage athletes.

23. Kicking chains. Kicking chains may be worn only in the stall. They shall be attached around the pastern and the free portion of the chain shall not exceed 25 cm in length. Each chain must swing freely and not be attached so as to have the effect of hobbles.

Figure 121.12 Bridles Allowed in Competitions Under USEF Rules Note: These rules apply only to tests ridden under Federation (National) rules. When the same tests are ridden under FEI rules, the requirements may be different. See the current FEI Rules For Dressage.

Competition	Snaffle Bridle	Double Bridle
USEF training, first, and second levels	✓	✗
USEF third and fourth levels	✓	✓
USEF FEI tests	✓	✓
USEF High Performance Qualifiers	✓	✓
USEF High Performance Championships	✗	✓
USEF Young Adult National Championships Qualifiers	✗	✓
USEF Young Adult Championships	✗	✓
USEF Young Rider National Championships Qualifiers	✓	✓
USEF Young Rider National Championships	✓	✓
USEF Junior National Championship Qualifiers	✓	✓
USEF Junior National Championships	✓	✓
USEF Dressage Test for 4-year- old horses	✓	✗
FEI Dressage Test for 4-year -old horses	✓	✗
FEI Dressage Test for 5-year-old horses	✓	✗
FEI Dressage Test for 6-year-old horses	✓	✗
FEI Dressage Test for 7-year-old horses	✓	✓
FEI North American Youth Championship Qualifiers	✓	✓
FEI North American Youth Championships	✓	✓
FEI Tests for Children	✓	✗
FEI Tests for Ponies	✓	✗
USEF Dressage Seat Equitation Classes	✓	✗



## A FURTHER EXPLANATION OF PROPERLY FITTED AND SECURED HEADGEAR:

What is “improperly” fitted headgear? A helmet that can move around or is falling down around the eyes is improperly fitted. It is improperly secured if the chinstrap of the harness is hanging down with clear “daylight” between the strap and the chin. The harness must not be able to slide forward around the chin. A rule of thumb is not more than two fingers should fit between skin and harness below the chin.

It is the competitor’s responsibility to enter the ring with the helmet properly fitted and secured. If the rider has not started their test, is on the outside of the arena when they notice that their helmet is loose, the rider can stop, make adjustments and utilize help from another individual if necessary. But the helmet can only be removed for adjustment if the rider dismounts. If the bell has rung, this adjustment can often be accomplished quickly and the rider can get into the ring before exceeding the 45 second limit for entry.

If the judge determines a competitor’s helmet is loose or that the harness has become unfastened during the test, they will signal the rider to stop. If the adjustment can be made quickly, with no outside help and without dismounting, the test can continue. If the fastener is broken, the rider is eliminated, should dismount and exit the ring. If the test delay exceeds 20 seconds, it is reasonable for the judge to eliminate, as they would for resistance.

A properly fitted helmet



Loose overall with loose harness



## Decorations on the horse are not permitted – What does this mean?

DR 121.15 states the following:

Mane, tail and body. Braiding of the horse's mane and tail is permitted. False tails are permitted, but a false tail may not contain any metal parts, except hooks. An existing wound or injury cannot be obscured. Decoration of the horse with extravagant items, such as ribbons, flowers or glitter in the mane, tail, or on the body, including hooves, is prohibited. Exception: A red ribbon in a horse's tail is permitted to identify a horse that kicks. Only standard horse colors that occur Naturally on that horse may be added to the mane, tail, or body.

Conservative colored bands or yarn may be used to secure braids, but no other items on the mane or tail. #1 is conservative colored blue yarn in the mane and is permitted.

Braiding of the mane is allowed in conservative colors but braids with bling are NOT PERMITTED.



Tails can be braided but not in extravagant ways.



Bling on hooves is NOT PERMITTED



Grooming the horse with his own hair coat is allowed but artificial items are not





The Crescent noseband (left) and the Kineton noseband (right) are **NOT PERMITTED**.



Bit Guards or Bit Burrs are **NOT PERMITTED**.



Complete reins with elastic inserts are **PERMITTED**.



Rein attachments are **NOT PERMITTED**.



Rein loops are **NOT PERMITTED**.  
Exception: if listed on an Athlete's Federation Classification/Dispensation Certificate.

## EXAMPLES OF DIFFERENT BITS



The mouthpiece of the bit must be smooth. This bit is a twisted wire and is **NOT PERMITTED**.



The mouthpiece of the bit must be smooth. This is a Knife Edge bit and is **NOT PERMITTED**.



The mouthpiece of the bit must be smooth. This bit is **NOT PERMITTED**.



A bit of multiple metals is **PERMITTED**.



A bit with inlaid metals is **PERMITTED**.





The Dr. Bristol snaffle is **NOT PERMITTED**.



The French Link snaffle (the center plate curves) is **NOT PERMITTED**.



Fager Alexander Sweet Iron Fixed Ring Note: Center link is flat like a Dr. Bristol. This is **NOT PERMITTED**.



Fager Carl Loose Ring (Flat center link). This is **NOT PERMITTED**.



Trust Equestrian Sweet Iron Dee French Link. This is **NOT PERMITTED**.



Hinged bits are **NOT PERMITTED**.



This bit has hinges and a thin metal (cable) in the mouthpiece and is **NOT PERMITTED**.



This type of loose ring eggbutt snaffle is **PERMITTED**.



The Golden Wings bit is **NOT PERMITTED**.



This variation of the Baucher bit is **PERMITTED**, but only as a snaffle; not as a bridoon.



This bit is **PERMITTED**.



A type of Baucher that is **PERMITTED** as a snaffle, but not as a bridoon.



Snaffle mouthpiece exceeds dimensions of permitted tongue relief and is **NOT PERMITTED**.

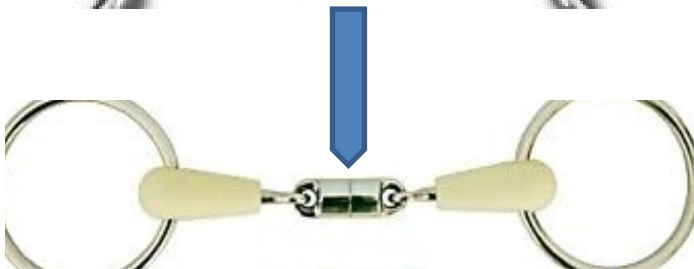

Happy Mouth revolver bit is **NOT PERMITTED**. The center link splits and rotates in the middle.



The mouthpiece of the bit must be a minimum of 10 mm thickness. This bit is too narrow.



Oxbow (left) and encased (closed toe) stirrups are allowed only if stated on a Federation Dispensation/ Classification Certificate.



## Examples of Bridles, Cavessons and Nosebands

**Combined Noseband** – This noseband has a jowl strap and can also be used with or without a traditional throatlatch. Three examples of LEGAL combined nosebands are shown below.

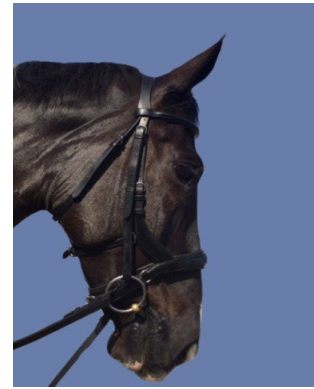

**Tota Comfort Dropped Noseband** - This cavesson is permitted only with a traditional noseband in addition to the jowl strap. Only one back strap is required above the bit (in addition to the chin strap below the bit).



**Micklem Noseband** - Permitted for use at any level where snaffles are permitted. Not permitted for use with a double bridle. Bit clips may not be used with this bridle.

## Examples of cavessons and crownpieces NOT PERMITTED for dressage



Crownpieces in all four of these photos are **NOT PERMITTED**. All are positioned too far behind the poll.

The Dyan bridle is pictured on left.



The three above are different views of the Antares bridles. Other brands with similar crownpieces are also not permitted.

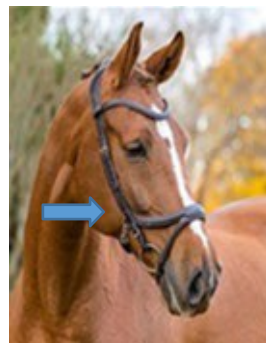

This cavesson is **NOW PERMITTED** without a throatlatch. Only one back strap is required (in addition to an optional flash on a snaffle bridle) above the bit. The back straps may be either a traditional throatlatch and cavesson, or a jowl strap.

The back strap on this bridle is now considered a jowl strap and not a cavesson, therefore, it is legal. However, note that the metal snap connecting the jowl strap is not allowed. The snap must be removed from the strap.



No throatlatch or jowl strap. This bridle is **NOT PERMITTED**.

The back straps must be either a traditional throatlatch and cavesson, or a cavesson and jowl strap.

Note that the back strap (chin strap) of a noseband cannot also be considered a jowl strap. Refer to the jowl strap illustration on page 11.



## Equipment Inspections

All equipment inspections for Level 1-3 shows are complete checks but do not include the bit(s). All equipment inspections for Level 4 & 5 shows are complete checks that include the bit(s).

### *How to properly check Dressage bits.*

*The process of checking bits must be done carefully and professionally. Safety, comfort, and cleanliness are all important. Ring stewards appointed by competition management must check saddlery and inspect bits and spurs on both sides of the horse for at least one-third of the horses in each class. Inspection of saddlery and bits must be done at the direction of the technical delegate. Inspection of saddlery and bits must be done immediately as the horse leaves the arena. (See DR126.2.i.1) The checking of the bridle must be done with the greatest caution, as some horses are very touchy and sensitive about their mouths. The bit inspector must use a new protective glove **on each hand** for each horse. **New gloves should be put on each hand as the horse approaches the ring steward. The ring steward must be careful not to touch other items (radio, pen, whip, etc.) before checking the bit on each side as this poses a bio-security concern.** Approach the horse quietly, ALWAYS inform the rider of your intent and ask them to loosen the noseband if necessary. When communicable disease is a concern, any deviations to established saddlery inspection protocol must be approved by the USEF Dressage Department prior to the competition. Calipers or other measuring devices should be cleaned between each use with a non-caustic disinfectant. **For information on checking nosebands, refer to page 12.***

- **For information on checking spur length and logos, refer to page 5.**



Diameter of bit is measured at the rings or cheeks of the mouthpiece.



Measurement of a snaffle bit to allow tongue relief. The maximum height of the deviation is 30 mm from the lower part of the tongue side to the highest part of the deviation. The widest part of the deviation must be where the mouthpiece contacts the tongue and must have a minimum width of 30 mm.

**Checking bits both visually and running the forefinger around the center joint is necessary to determine each bit's legality.**

The following "Bomber" bit examples are **NOT PERMITTED** as a snaffle or as a bridoon in a double bridle, but you might not find the problem unless you check these bits from all sides! These particular "Bomber" bits are advertised as bridoons with mouthpieces that "lock up". All Bridoons must have a flexible joint (no mullen mouth or mouthpiece that locks). Also, these bits have "angular" edges, which are not permitted.





The “angular” edges in this view of one of the bits above are clearly evident.



The Lorenzini snaffle pictured immediately above looks legal in the photo on the left, but the photo on the right shows the other side of the bit. It is **NOT PERMITTED** due to the center link that is not smooth.